



7183

DISPLAY STORAGE TUBE

Writing Gun: Magnetic Deflection,
Electrostatic Focus

Viewing Gun: No Deflection,
No Focus

Direct-View Type
4"-Diameter Display

Non-Equilibrium Writing
Grid-Control Reading (Viewing)

5"-Diameter Bulb
11-5/8" Overall Length
Writing-Gun Neck
Viewing-Gun Neck

TENTATIVE DATA

RCA-7183 is a 5-inch display storage tube of the direct-view type designed for use in applications where it is desired to have a bright, non-flickering display of stored information for

20 or more seconds after writing has ceased. Practical applications of the 7183 include: airplane-cockpit radar display; airport surveillance; data transmission including half-tones; and visual communications requiring steady, non-flickering, narrow bandwidth transmission over telephone lines.

Performance of the 7183 when operated with 8,500 volts on the screen is characterized by a full 4-inch-diameter display having brightness of about 1500 foot-

lamberts, and good resolution capability in half-tone displays.

The 7183 utilizes two electron guns—a writing gun and a viewing gun, each in its own neck. The writing gun utilizes electrostatic focus and produces an electron beam which is magnetically deflected by external deflecting coils. The viewing gun produces an electron stream which floods the electrodes controlling the storage function and the brightness of the display.

PRINCIPLES OF OPERATION

As shown in Fig. 1, the 7183 has a writing section and a viewing section. The *writing section* contains an electrostatically focused gun that

produces an electron beam which is magnetically deflected. The *viewing section* contains an aluminized screen on the inside surface of a flat faceplate, a backplate capacitively coupled to a storage grid, and a viewing gun having five grids.

The Viewing Operation

In addition to the viewing gun with its grids No. 1 and No. 2, the viewing section contains a grid No. 3, a grid No. 4, a grid No. 5, a storage grid, a backplate capacitively coupled to the storage grid, and a screen having excellent visual efficiency. The spectral-energy emission characteristic of the screen phosphor is shown in Fig. 2.

The viewing gun provides a low-velocity electron stream which continuously floods the electrodes (grid No. 5, storage grid, and backplate) controlling the storage function and the brightness of the display. A display with high brightness is possible because of the high viewing-gun current. The high current can be utilized because the viewing beam is not controlled by methods ordinarily employed in cathode-ray tube guns and is consequently not limited by focusing, deflection, and modulation requirements.

Grids No. 3 and No. 4 each consist of a conductive-coating band positioned on the bulb-wall interior as shown in Fig. 1. These electrodes collimate (make parallel) the paths of the electrons in the stream before they reach grid No. 5. Collimation is required so that the low-velocity electrons will approach the storage grid in paths perpendicular (normal) to the plane of the storage grid. This normal approach of the electrons to every point on the storage grid together with their uniform velocity makes possible uniform control of the electrons by the storage grid.

Grid No. 5 consists of a fine metal mesh together with a conductive-coating band on the bulb-wall interior. It serves to accelerate electrons in the beam; to repel any positive ions, produced by collision of electrons with residual gas molecules in the region between base and grid No. 5, from landing on the storage grid and thus rapidly wiping out a stored charge pattern; and to collect beam electrons turned back near the storage grid when its potential is negative.





The storage grid consists of a very thin deposit of excellent insulating material covering the gun side of the backplate which is the framework of a fine metallic mesh. The deposit leaves

which produce saturation brightness, the number of electrons which penetrate the storage-grid openings, and hence the amount of light emitted by the screen, is a function of the storage-grid potential, as shown in Fig.4 for conditions with a screen voltage of 8500 volts and a backplate voltage of 0 volts. For backplate and/or screen voltages more positive than those indicated in Fig.4, the storage-grid characteristic tends to shift to the left and to exhibit less slope. For backplate and/or screen voltages less positive than those indicated in Fig.4, the characteristic tends to shift to the right and to exhibit more slope.

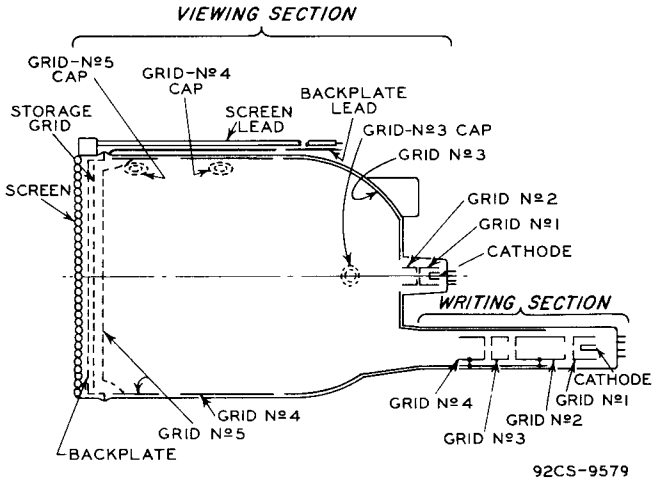

Fig. 1 - Schematic Arrangement of Type 7183.

the size of the openings in the mesh essentially unchanged. In effect the storage grid consists of a multiplicity of storage elements, each capacitively coupled to the mesh.

The storage grid serves to control the viewing beam so that the stored information can be displayed on the phosphor (screen). If the storage-grid potential is made sufficiently negative with respect to the viewing-gun cathode, electrons in the viewing beam are turned back as they approach the storage grid and are collected by grid No.5. Under this condition, the viewing beam is cut off.

When the storage grid is at the same potential as the viewing-gun cathode, electrons in the viewing beam approach sufficiently near the plane of the storage grid to be attracted by the viewing-screen field which penetrates the openings in the storage grid. Under the influence of this field, a majority of the viewing-beam electrons which have passed through grid No.5 are accelerated through the storage-grid and backplate openings to the phosphor (screen), and cause it to fluoresce brightly over its entire area. Under this condition, the brightness of the screen is designated as "saturated brightness".

Light output from the screen under conditions of saturated brightness varies with the voltage applied to the screen. This relationship is shown in Fig.3 for a typical 7183 operating under conditions of optimum collimation. Because the screen is aluminized, the light output drops off very rapidly at screen voltages below 5000 volts. Operation below this value is not recommended.

At values of storage-grid potential between those which produce viewing-beam cutoff and those

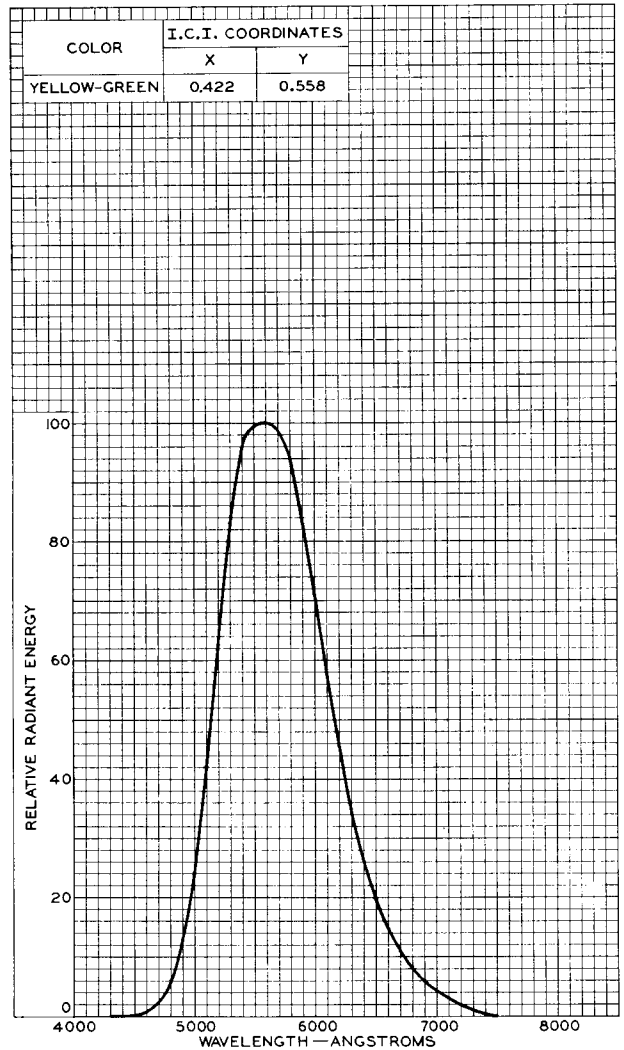

92CM-7647RI

Fig. 2 - Spectral-Energy Emission Characteristic of Phosphor P20 Used in Type 7183.

Within the range of storage-grid potentials considered thus far, no viewing-beam electrons are attracted to the surface of the storage grid. Hence, in the absence of deliberate writing,



Leakage through the insulating material, or spurious charging such as might be caused by positive-ion bombardment, a charge pattern once established on the storage grid should remain indefinitely. If, however, the storage grid is made positive with respect to the viewing-gun cathode, viewing-beam electrons are attracted to the surface of the storage grid and land on it. If the electrons which land do not have sufficient energy to produce a secondary-electron emission ratio in excess of unity, a net flow of current into the storage grid will result. Because the storage grid is conductively isolated from the metallic backplate, the storage grid is free to charge negatively under the influence of this current.

This negative-charging phenomenon provides a mechanism by means of which an undesired charge pattern on the storage grid can be removed, i.e., erased. For example, assume that the entire storage grid has been charged, by writing, to zero potential with respect to the cathode of the viewing gun. The cathode of the viewing gun is usually taken as a ground reference. Now, assume that the backplate is suddenly shifted from its "dc" potential level of 0 volts to a positive potential of 10 volts. Because of the very close capacitive coupling between the backplate and the storage grid, the storage grid also rises to a potential of 10 volts. Viewing-beam electrons are now able to land on the storage grid and negative charging of the storage grid takes place, as explained above. Charging continues until the storage-grid potential is reestablished at zero volts. When this occurs, viewing-beam electrons can no longer land on the storage grid. Now, if the backplate potential is returned to its initial value of zero volts, the storage-grid potential drops correspondingly to -10 volts. This negative voltage, as may be seen by referring to Fig.4, essentially cuts off the viewing beam of a typical 7183 and thus erases any charge pattern on the storage grid.

Following erasure, the time available for writing and viewing is limited by the presence of positive ions produced by collision of electrons in the viewing beam with residual traces of gas in the region between the screen and grid No.5. These positive ions are attracted to the most negative elements of the storage grid. On landing, the ions cause the elements to assume a less-negative charge and thus to increase the flow of viewing-beam electrons to the screen. Thus, the limit of viewing duration is determined by loss of contrast in the viewed pattern rather than by a decay of brightness as in the case of long-persistence phosphors.

In some applications, it may be desirable to sacrifice brightness for a viewing duration longer than that indicated in the tabulated data. Extended viewing duration may be obtained by modulating the viewing beam with rectangular

or pulses applied to grid No.1 of the viewing gun at a pulse repetition frequency above that which produces display flickering. The minimum usable frequency is determined by the persistence characteristic of the screen phosphor and is in

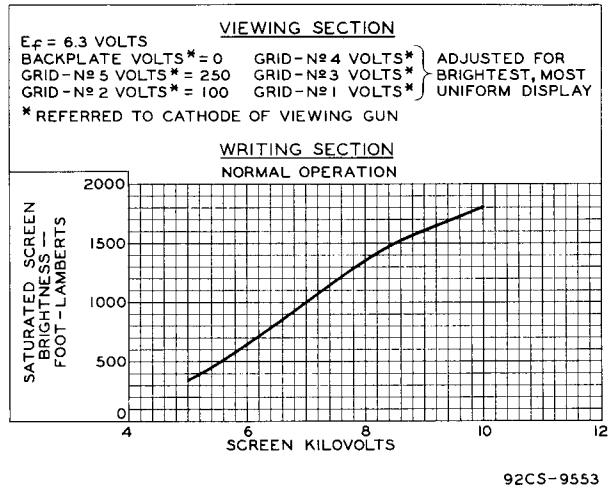

Fig.3 - Typical Characteristic of Type 7183.

the order of 30 pulses per second. Screen brightness varies directly and viewing duration varies inversely with the grid-No.1-pulse duty cycle.

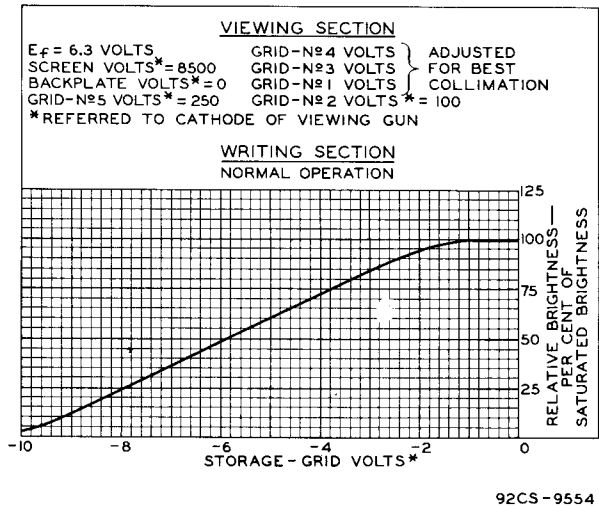

Fig.4 - Typical Storage-Grid Characteristic of Type 7183.

The Writing Operation

The writing gun is similar to that used in electrostatically focused and magnetically deflected oscillograph tubes, and produces a well-defined focused beam having exceptionally small effective area at the storage grid. This beam may be deflected and modulated in the same manner



as for oscillograph tubes. It has a control function and contributes little to the total light output from the tube.

The cathode of the writing gun is generally operated at -2500 volts with respect to the viewing-gun cathode.

The writing-beam electrons landing on the storage grid have sufficient velocity to produce a secondary-electron emission ratio greater than unity. Thus, more electrons leave the storage grid than arrive, and those elements on the storage grid scanned by the beam assume a less-negative charge wherever the writing beam strikes. Because the secondary electrons are attracted to grid No.5 of the viewing gun, the writing beam tends to charge the storage grid to the potential of grid No.5 of the viewing gun. However, the maximum potential to which an element of the storage grid rises above cutoff is limited in normal operation of the tube by the viewing-gun beam to a potential just slightly more positive than that of the viewing-gun cathode.

The writing-beam electrons which land on a storage element determine the voltage built up across the dielectric and the corresponding net charge stored in the dielectric. By controlling the amplitude and duration of the writing-beam current, it is possible to establish on any storage element a positive charge having a value which will partially or completely counteract that element's negative charge. Consequently, a storage element can be charged to any potential intermediate between the storage-grid-cutoff voltage and zero voltage.

As considered previously, the potential of any storage element determines the number of viewing-beam electrons passing through the storage grid in the immediate vicinity of that element. When the potential is such as to allow passage of electrons, these electrons are accelerated and strike the screen directly opposite the storage element. As a result, they produce a luminescent spot having a size only slightly larger than that of the storage element and a brightness which is directly proportional to their density and their velocity which is determined by the screen potential.

Because the potential of a storage element is not changed by the viewing operation, a charge pattern established by the writing gun on the storage grid produces a corresponding visible pattern on the screen which may be viewed for a period determined by positive-ion build-up or by the predetermined erasure rate when dynamic erasure is employed.

The multiplicity of storage elements on the storage grid permits storage of half-tone patterns and their display. At a display brightness approximately 50 per cent of saturated brightness, half-tone patterns have a resolution of about 50 lines per inch as measured by the "shrinking raster" method.

The Erasing Operation

In the section headed *The Viewing Operation*, a technique for erasing stored charge patterns was described. This technique, known as *static erasure*, has the following disadvantage. During the erasing cycle and the time thereafter required

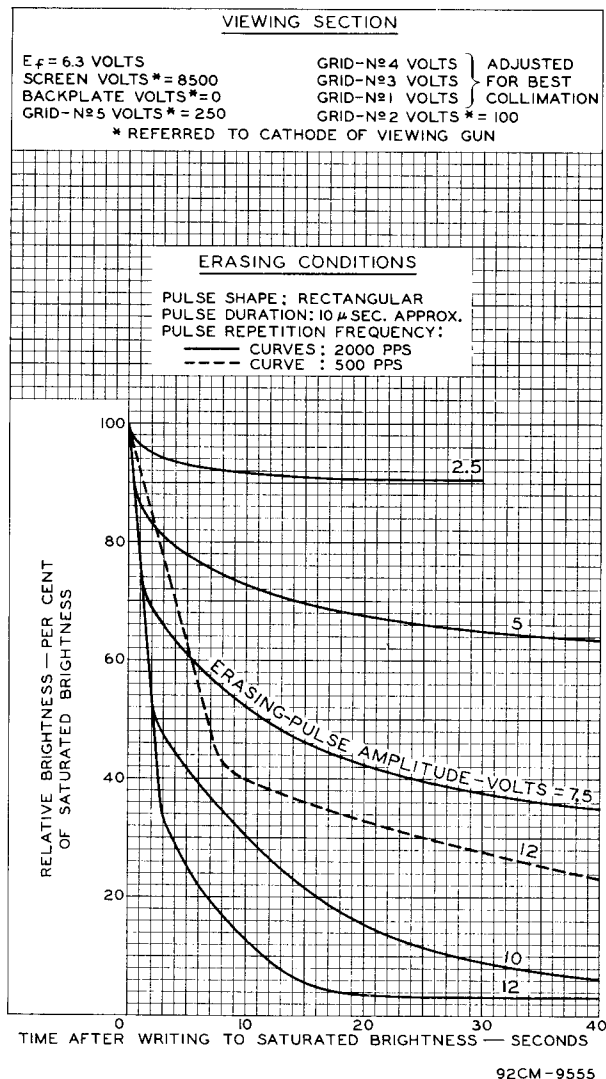

Fig.5 - Typical Erasure Characteristics of Type 7183.

to write a new pattern, the display conveys no information or incomplete information. It is also to be noted that during the static erasing cycle, the screen is uniformly illuminated at a level equal to, or greater than, the saturated brightness level.

In most applications of the 7183, it is desired that writing be followed by a gradual decay of stored information. This kind of performance is obtained by applying a continuous series of pulses to the backplate at a rate no lower than the phosphor flicker frequency (refer to section



headed *The Viewing Operation*). The technique of erasing by applying a series of pulses to the backplate is known as *dynamic erasure*.

The amount of charge erased during each erasing pulse is dependent on the duration, amplitude, and shape of the pulse. These factors together with the erasing-pulse repetition frequency determine the observed rate of decay of stored information.

Brightness-decay characteristics for a typical 7183 erased dynamically are shown in Fig.5. Each of these curves may be described as consisting of a linear portion followed by a quasi-exponential portion. It will be observed that erasing pulses whose amplitude is smaller than the magnitude of the viewing-beam cutoff voltage do not permit complete erasure. On the other hand, erasing pulses whose amplitude is greater than the magnitude of the viewing-beam cutoff voltage eventually drive the storage grid beyond cutoff, i.e., to a value "blacker than black".

The choice of erasing-pulse amplitude depends on the application contemplated by the equipment designer. When a linear decay is required, the erasing-pulse amplitude should be set so that the transition of the decay characteristic from linear to quasi-exponential occurs at or near viewing-beam cutoff. If at the same time it is desired to display weak input signals, it is necessary to adjust the writing-beam "unblanking" level in the absence of input signals so that the writing beam charges the storage grid just to the cutoff level at the instant of writing.

The characteristics shown in Fig.5 represent typical performance at two settings of erasing-pulse duty cycle. Decay performance at other duty cycles may be estimated by noting that the slope of the linear portion of these curves is directly proportional to the erasing-pulse duty cycle. The effect of erasing-pulse duty on the quasi-exponential portion of the curves is less well defined. For purposes of estimation, the following rough approximation may be used: the initial slope of the quasi-exponential portion varies as the 1-1/2 power of the erasing-pulse duty cycle for values of duty cycle between about 0.01 and 0.1.

It will also be observed in Fig.5 that in no case does the dynamic-erasure process result in zero screen brightness. The reason is that some screen illumination is caused by the application of the erasing-pulse series. The background brightness for a given erasing duty cycle may be estimated by multiplying 1.5 times the saturated-brightness value by the erasing duty cycle.

In the above considerations, the use of rectangular erasing pulses is assumed. When triangular erasing pulses are used, the linear portion of the dynamic decay curves in Fig.5 is transformed into an exponential shape and the

remaining portion of the curves is changed into an ever-more-slowly-varying function.

DATA

General:

	Writing Section	Viewing Section	
Heater, for unipotential Cathode:			
Voltage (AC or DC)	6.3 ± 10%	6.3 ± 10%	volts
Current	0.6	0.6	amp
Cathode Heating Time (Minimum) before other electrode voltages are applied.	—	30	sec
Direct Interelectrode Capacitances (Approx., without external shield):			
Grid No.1 to all other tube electrodes.	7	7.5	μf
Cathode to all other tube electrodes.	5	5	μf
Backplate to all other tube electrodes	—	300	μf
Focusing Method.	Electrostatic	None	
Deflection Method.	Magnetic	None	
Deflection Angle	See Fig.7	—	
Phosphor	—	P20, Aluminized	
Fluorescence	—	Yellow-Green	
Phosphorescence.	—	Yellow-Green	
Minimum Useful Screen Diameter			4"
Maximum Overall Length			11.62"
Seated Length.			11.16" ± 0.10"
Maximum Tube Radius.			3.00"
Maximum Tube Diameter.			5.19"
Greatest Bulb Diameter			5.00" ± 0.06"
Base:			
Writing Gun.	Small-Button Neoditetra 8-Pin (JETEC No.EA-49)		
Viewing Gun.	Small-Button Miniature 7-Pin (JETEC No.E7-1)		
Bulb Terminals:			
Caps (Three)	Recessed Small Cavity (JETEC No.J1-21)		
Flexible leads (Two)	See <i>Dimensional Outline</i>		
Temperature Range.			-65° to +100° C
Operating Position			Any
Weight (Approx.)			1-3/4 lbs

Maximum Ratings, Absolute Values:

	Writing Section	Viewing Section	
SCREEN VOLTAGE	—	10000 max.**	volts
BACKPLATE VOLTAGE (Peak)	—	30 max.**	volts
	<i>Equivalent Values</i>	<i>Equivalent Values</i>	
GRID-No.5 VOLTAGE.	—	—	300 max.** volts
GRID-No.4 VOLTAGE.	2900 max.*▲	150 max.**	150 max.** volts
GRID-No.3 VOLTAGE.	1200 max.*	—	2900 max.*▲ 150 max.** volts
GRID-No.2 VOLTAGE.	2900 max.*▲	150 max.**	150 max.** volts
CATHODE VOLTAGE.	—	-2750 max.**	— volts
GRID-No.1 VOLTAGE:			
Negative bias value.	200 max.*	100 max.**	volts
Positive bias value.	0 max.*	0 max.**	volts
Positive peak value.	2 max.*	0 max.**	volts
PEAK HEATER-CATHODE VOLTAGE:			
Heater negative with respect to cathode.	125 max.*	125 max.**	volts
Heater positive with respect to cathode.	125 max.*	125 max.**	volts



VIEWING SECTION**

Operating Values and Typical Performance Characteristics:

To prevent possible damage to the tube, allow the viewing-gun beam current to reach normal operating value before turning on the writing-gun beam current, and keep the viewing beam on till the writing beam is turned off.

Screen Voltage.	8500	volts
Backplate Voltage (DC).	0	volts
Grid-No.5 Voltage#.	220 to 250	volts
Grid-No.4 Voltage#.	40 to 100	volts
Grid-No.3 Voltage#▲.	$\left\{ \begin{array}{l} 10 \text{ to } 40^{**} \\ 2510 \text{ to } 2540^{*} \end{array} \right.$	volts
Grid-No.2 Voltage#.		100
Grid-No.1 Voltage#.	0 to -75	volts
Maximum Screen Current.	0.6	ma
Maximum Backplate Current (Peak).	2	ma
Maximum Grid-No.5 Current●.	2.4	ma
Maximum Grid-No.4 Current●.	0.3	ma
Maximum Grid-No.3 Current●.	0.5	ma
Maximum Grid-No.2 Current●.	0.08	ma
Maximum Cathode Current●.	4	ma
Number of Half-Tone Steps□.	5	
Viewing Duration▲▲.	20	sec
Maximum Erasing-Uniformity Factor: □□		
For 4"-diameter area (A_4).	0.65	
For the 3.5"-diameter portion ($A_{3,5}$) centered on A_4	0.50	
Resolution#	50	lines/in.
Brightness●.	1500	f1

WRITING SECTION*

Operating Values:

	Equivalent Values		
Grid-No.4 Voltage#▲.	2510 to 2540*	10 to 40**	volts
Grid-No.3 Voltage for Focus	425 to 925*	-	volts
Grid-No.2 Voltage#▲.	2510 to 2540*	10 to 40**	volts
Maximum Grid-No.1 voltage for Cutoff of Undelected Focused Spot	-130*	-2630**	volts
Cathode Voltage	-	-2500**	volts
Maximum Grid-No.3 Current	-15 to +10		ma
Maximum Peak Cathode Current.	4.5		ma

VIEWING SECTION and WRITING SECTION

Circuit Values:

Grid-No.1-Circuit Resistance (Either gun)	1.0 max.	megohm
Series Current-Limiting Resistor (Unbypassed) in Grid-No.5 (Viewing Section) Circuit.	0.005 min.	megohm
Backplate-Circuit Resistance.	0.005 max.	megohm
Series Current-Limiting Resistance in Screen Circuit.	1.0 min.	megohm

** Voltages are shown with respect to cathode of Viewing Gun.

* Voltages are shown with respect to cathode of Writing Gun.

▲ Grids No.2 and No.4 of Writing Gun are connected together and to grid-No.3 of Viewing Gun within the tube.

Adjusted for brightest, most uniform pattern.

● For conditions with combined adjustment of grid-No.1 voltage, grid-No.2 voltage, grid-No.3 voltage, and grid-No.4 voltage to give brightest, most uniform pattern. After final adjustment, the grid-No.1 voltage should not be more positive than -20 volts to maintain electrode current within the maximum value indicated.

□ Observed with an RCA-2F21 Monoscope display.

▲▲ Expressed in terms of the time required for the brightness of the unwritten background to rise from just zero brightness (viewing-beam cutoff) to 10% of saturated brightness.

□□ Determined as follows: With no erasing pulse, overscan the storage surface with writing beam to obtain maximum pattern brightness. Then cut off writing beam and adjust erasing pulse to obtain complete erasure in approximately 10 seconds. Measure time (t_1) from start of erasing to the instant at which any area within the 4" diameter (or the 3.5"-diameter portion) is reduced to background-brightness level, and time (t_2) from start of erasing to the instant at which the entire area within the 4" diameter area (or the 3.5"-diameter portion) is reduced to background-brightness level. The erasing-uniformity factor is defined as $(t_2 - t_1) / t_2$.

Measured by shrinking-raster method at a display brightness of 50% of saturated brightness and with grids No.2 and No.4 of Writing Gun at about +2500 volts with respect to cathode of Writing Gun.

● Measured with entire storage grid written to produce saturated brightness and with screen at indicated voltage.

● The cathode of the Writing Gun is operated at about -2500 volts with respect to the cathode of the Viewing Gun which is usually operated at ground potential.

OPERATING CONSIDERATIONS

The maximum ratings in the tabulated data for the 7183 are limiting values above which the serviceability of the 7183 may be impaired from the viewpoint of life and satisfactory performance. Therefore, in order not to exceed these absolute ratings, the equipment designer has the responsibility of determining an average design value below each absolute rating by an amount such that the absolute values will never be exceeded under any usual condition of supply-voltage variation, load variation, or manufacturing variation in the equipment itself. Information as to altitudes at which the maximum voltage rating applies may be obtained on request.

Handling. The 7183 should preferably be transported or handled with the face up to prevent any loose particles in the tube from striking the storage surface and adhering to it. Care should be taken to prevent knocking or bumping the encapsulated junction of the screen lead with the bulb, or striking the tape-covered backplate flange. Such rough treatment will cause either immediate or delayed cracking of the respective metal-glass seals. The flexible leads should not be bent at a sharp angle. Doing so may crack their insulation.

Support and shielding for the 7183 may be provided by a shield made of properly annealed high-permeability material. A working drawing No.92CM-9584 of a suitable shield for the 7183 may be obtained on request from Commercial Engineering, RCA, Harrison, N.J. Support members of nonmagnetic material may be fastened to the shield for mounting in the equipment. In working with high-permeability material, it is essential to follow standard practice to prevent altering the shielding properties of the material. The screen lead and the backplate lead should be placed outside the shield.

Terminal Connections. The base pins of the neoditetrar 8-pin base on the Writing-Gun neck fit the ditetrar 8-contact connector, such as Cinch No.54A18088, or equivalent. The base pins of the miniature 7-pin base on the Viewing-Gun neck fit the miniature 7-contact socket. The recessed cavity caps require standard flexible-lead connectors as used for television picture tubes. The screen is terminated in a large-diameter, flexible, high-voltage lead integral with the tube. The backplate is terminated in a small-diameter, flexible lead integral with the tube.

Power-Supply Requirements. A typical power-supply circuit to provide the operating voltages for the 7183 is shown in Fig.6.

For the Writing Gun, the dc supply should be well regulated so that focus will not change with the video modulation. The heater winding

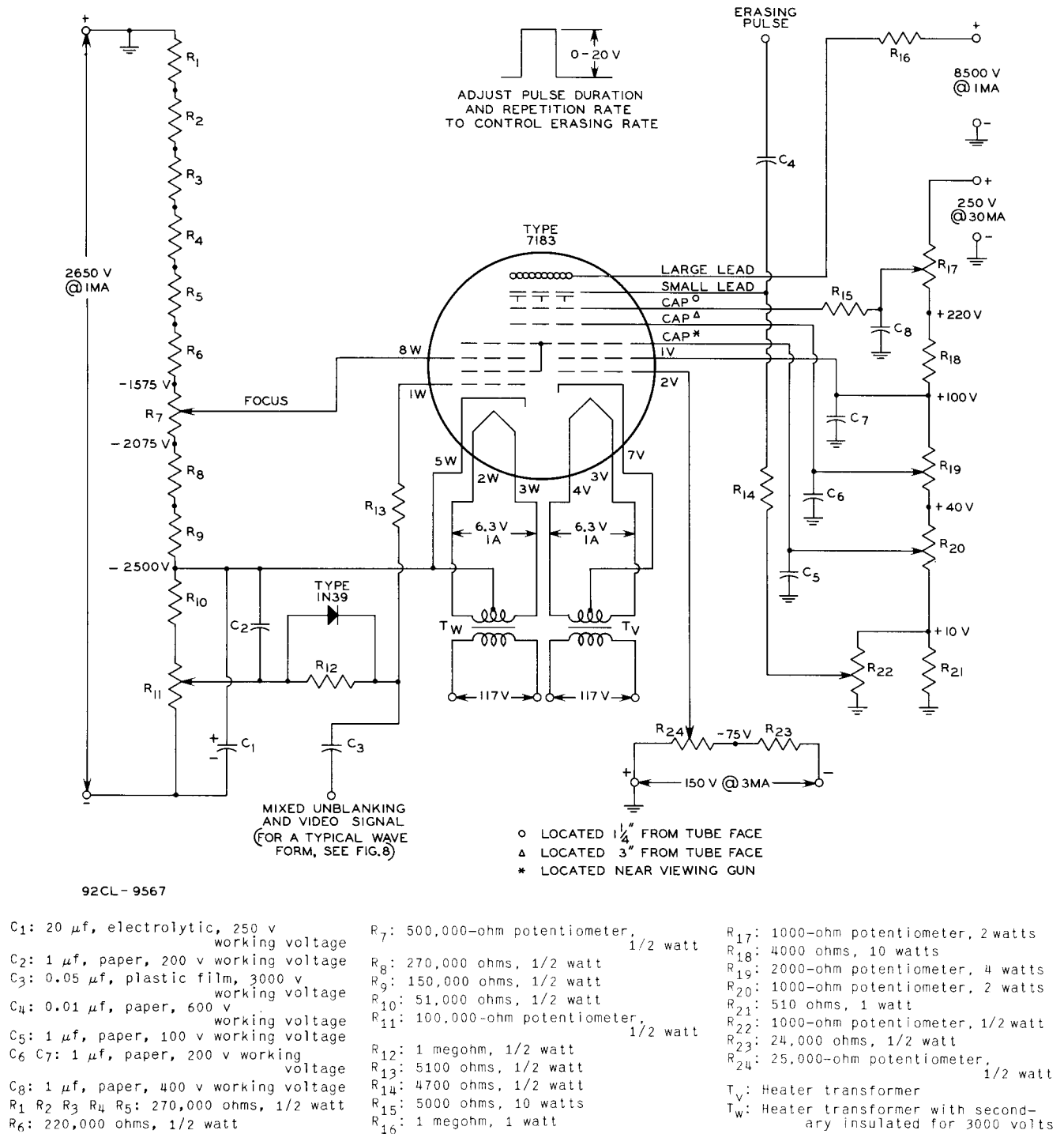

Fig. 6 - Typical Power-Supply Circuit for Type 7183.

should be insulated to withstand operation at high negative potential with respect to ground.

For the Viewing Gun, it is recommended that the +100 volts for grid No.2 as well as the +250 volts for grid No.4 be stable. An unbypassed resistor of at least 5000 ohms, should be connected

in series with the grid-No.5 terminal cap. This provision will protect the tube against possible damage if internal sparking should occur.

The high-voltage dc supply for the screen should have its negative terminal grounded, and should have at least a 1-megohm resistor in



series with the screen terminal. This provision will protect the tube against possible damage if internal sparking should occur.

The high voltages at which the 7183 is operated may be very dangerous. Great care should be taken in the design of apparatus to prevent the operator from coming in contact with the high voltages. Safety precautions include the enclosing of high-potential terminals and the use of interlocking switches to break the primary circuit of the power supply when access to the equipment is desired.

In the use of high-voltage tubes, it should always be remembered that high voltages may appear at normally low-potential points in the circuit as a result of capacitor breakdown or incorrect circuit connections. Therefore, before any part of the circuit is touched, the power-supply switch should be turned off, and both terminals of any capacitors grounded.

Deflection Considerations. The undeflected focused writing beam normally strikes the storage-grid surface at its point of intersection with the writing-gun axis. The writing-gun axis is perpendicular to the plane of the storage grid and intersects the tube face at a distance 1-1/2 inches from its center.

The writing beam may be deflected by either a mechanically rotating pair of coils diametrically opposite each other, or by two stationary pairs of coils. In the latter case, one pair is used for horizontal deflection; and the other, for vertical deflection.

When a rotating pair of coils* is used, centering of the undeflected writing beam, as required for a PPI scan, may be accomplished by means of a centering device of either the electro-magnetic or permanent-magnet type. This device is mounted on the writing-gun neck back of the rotating deflecting coils.

When stationary coils are used, centering of the undeflected writing beam is preferably accomplished by passing direct current of the required value through each pair of deflecting coils.

To avoid neck shadow, it is essential that the center of deflection of the rotating 2-coil yoke be located not more than 0.5 inch from the Reference Line (see Fig.7), and the center of deflection of the associated centering magnet be located not more than 1.3 inch from the Reference Line. For the stationary 4-coil yoke, the center of deflection should be located not more than 0.8 inch from the Reference Line. For each of the deflection centers, the corresponding angles through which the writing beam is deflected from the writing-gun axis are also shown in Fig.7.

* For rotating yokes to be used with the 7183, consult manufacturers such as Syntronic Instruments Inc., 100 Industrial Road, Addison, Ill.; and Industrial Electronic Products 15-5, RCA, Camden, N.J.

Video-Drive Considerations. The information to be stored and displayed by the tube should be applied as a video signal to the control grid (grid No.1) or cathode of the Writing Gun. In determining the writing drive requirements, it should

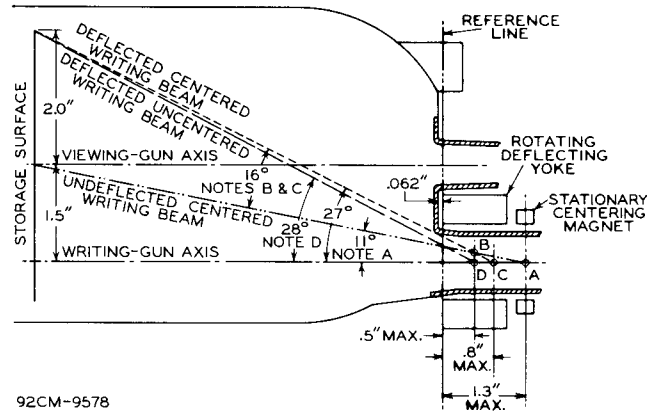

- NOTE A:** Centering of the writing beam on the storage surface is necessary for a centered PPI display. The beam is centered by shifting it from the writing-gun axis through an angle of 11° with a centering magnet whose effective center (A) is located 1.3" from Reference Line.
- NOTE B:** With rotating yoke whose effective center of deflection (B) is located 0.5" from Reference Line, the centered writing beam (NOTE A) must be deflected through an angle of 32° to sweep fully the storage surface.
- NOTE C:** With stationary TV-type yoke whose effective center of deflection (C) is located 0.8" from Reference Line, the centered writing beam must be deflected through an angle of 32° to sweep fully the storage surface.
- NOTE D:** When rotating yoke is used with uncentered display, i.e., the writing beam is not centered (NOTE A) but strikes the storage surface on the writing-gun axis, and with the effective center of deflection of the rotating yoke located 0.5" from the Reference Line, the uncentered writing beam must be deflected through an angle of 56° to sweep fully the storage surface.

Fig.7 - Angles of Deflection and Centers of Deflection for Writing Gun of Type 7183 When Used With Rotating 2-Coil Yoke and Stationary 4-Coil Yoke.

be remembered that writing is essentially a charge-depositing process. The instantaneous writing-beam current needed for saturated writing varies nearly directly with the speed at which the writing beam is deflected across the storage grid and varies inversely with the number of times a given storage element is written upon in one complete scan period.

The dc bias and the video-signal amplitude applied to grid No.1 or cathode of the Writing Gun should be adjusted to give a writing speed appropriate to the rate of scanning used.

In applications where a PPI-type display is contemplated, it is necessary to arrange for the application of "tilt" to the "unblanking" gate on which the video input signal is superimposed. In some cases, it is also necessary to modulate the gain of the video-amplifier system as a function of the applied deflection current. For example, in the case of a PPI display off-centered by



1.5 inches from the center of the useful display area, it has been found that the writing-grid-No.1 waveform illustrated in Fig.8 gives a satisfactory display with a typical 7183.

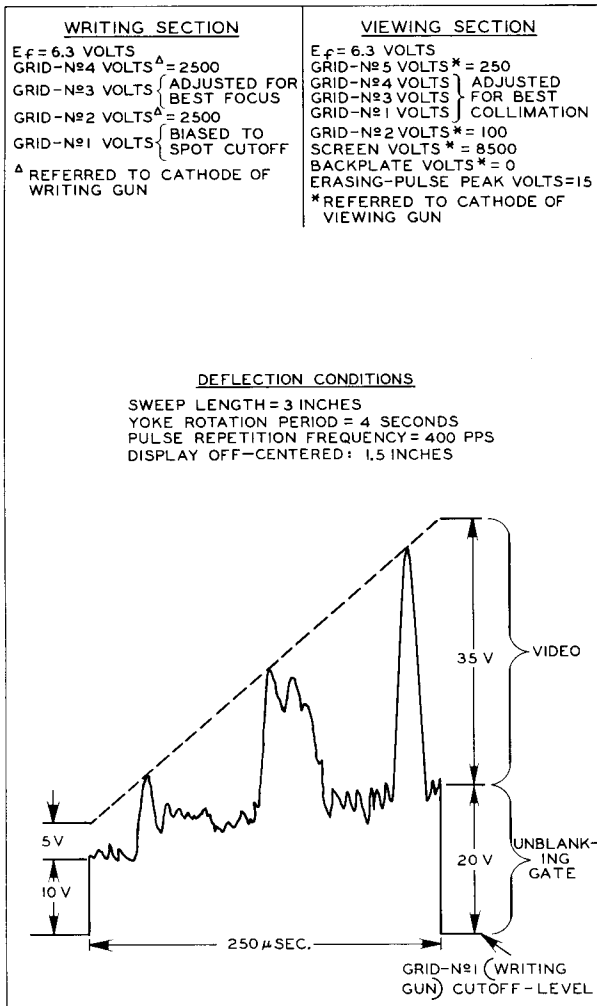

92CM-9560

Fig.8 - Writing-Grid-No.1 Driving Waveform for Typical 7183 in a Specific PPI Display Application.

Runaway Charging. A condition of runaway charging of the storage grid may result if the writing beam is allowed to land on the storage grid with the viewing beam turned off, if the writing beam is incident on an area of the storage grid not covered by the viewing beam, or if the density of the writing beam exceeds that of the viewing beam. Such a runaway condition can occur because of the non-equilibrium writing process involved.

Because the electrons in the writing beam land with an energy such that the secondary-emission ratio of the storage-grid surface is

greater than unity, this surface charges positive toward the potential of grid No.5 of the viewing section. Normally, the landing on the storage grid of the viewing-beam electrons keeps any portion of the storage-grid surface from charging above viewing-beam cathode potential. When this limiting action of the viewing beam is not present, the storage-grid surface may charge under the action of the writing beam to a value such that sparking occurs through the insulating layer between the storage-grid surface and the backplate. This sparking is observed as random bright flashes on the screen. If the writing process is quickly stopped, generally no permanent damage (loss of

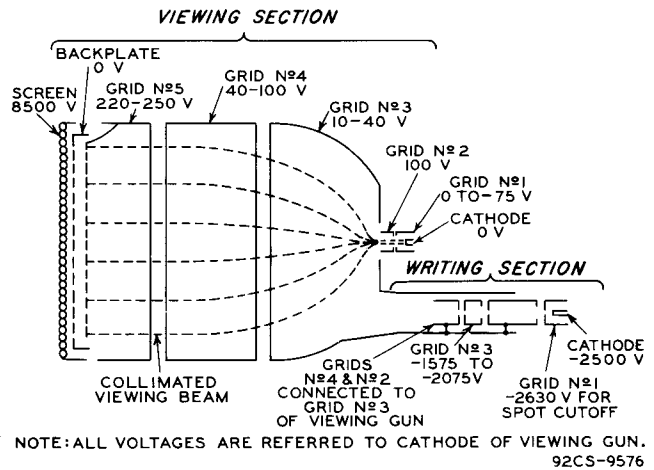

Fig.9 - Schematic Representation of Electron-Lens System With Electrode Voltages, and Collimated Viewing Beam, in Type 7183.

the ability to store a signal in localized areas) will occur to the insulating layer.

A condition of runaway charging and/or damage to the aluminized screen can also occur if an unmodulated writing beam is allowed to remain stationary in a spot on the storage grid even with the viewing beam turned on.

If runaway charging has occurred, portions of the storage-grid surface may be in the order of 100 volts positive with respect to the backplate. To remove this charge, the following procedure is necessary. First, the screen supply is turned off. Then, the backplate lead is disconnected from its normal voltage source and connected for a few seconds to the grid-No.5 (viewing section) voltage of about 250 volts. Since there is then no collecting field at the storage-grid surface, secondary electrons can not leave it and its positive potential will be decreased by the viewing-beam electrons to a value near that of the backplate. The backplate is then connected to its normal voltage supply, and the screen supply is turned on. The storage-grid surface should now erase in the normal manner. In carrying out this procedure, it is



important that the backplate be switched discontinuously between the potentials involved and not be varied gradually between them as would be done by adjusting a potentiometer. Switching discontinuously from initial to final potentials will prevent re-establishment of a high potential across the dielectric, whereas gradual adjustment will re-establish such a potential.

Set-Up Procedure. The following steps should be followed when first placing the 7183 in operation. *Electrode voltages are referred to the cathode of the viewing gun unless otherwise specified.*

To prevent possible damage to the tube, allow the viewing-gun beam current to reach normal operating value before turning on the writing-gun beam current, and keep the viewing beam on till the writing beam is turned off.

1. Apply power to the heater of the *viewing gun* and allow 30 seconds for the cathode to reach normal operating temperature. Then, set the voltages on the viewing-gun electrodes, with reference to Fig. 9 as follows:

Grid No. 1 (G_{1V}): -10 volts
Grid No. 2 (G_{2V}): 100 volts
Grid No. 3 (G_{3V}): 40 volts
Grid No. 4 (G_{4V}): 100 volts
Grid No. 5 (G_{5V}): 250 volts
Backplate: 0 volts
Screen: 8500 volts

2. Apply power to the heater of the *writing gun* and allow 30 seconds for the cathode to reach normal operating temperature. Then, with reference to Fig. 9 and to the tabulated data under *Writing Section*, set the grid-No. 1 voltage to cutoff, and apply dc voltages to the electrodes of the writing gun. With the storage surface newly erased (refer to *The Erasing Operation*), the grid-No. 1 bias is slowly reduced until the writing beam is seen as a spot on the screen. If the beam is caused to move, either by centering adjustment or by application of deflection field, it should leave a bright trace. After an area has been written to full brightness, the writing-beam spot may be seen as a slightly brighter spot on the bright background. Writing-beam focus can then be optimized by adjusting the grid-No. 3 voltage of the writing gun.
3. Write over the full screen area until bright areas show saturation. For example, a PPI sweep speed of approximately 10000 inches per second at a pulse-repetition frequency of approximately 400 pps and a rotation rate of 15 rpm, with a writing-gun drive of about 15 volts from grid-No. 1 cutoff should

stabilize the storage surface, i.e., bring all of the storage elements into condition such that they will transmit the viewing beam, in about 10 sweeps. When other deflection methods, such as TV-type or "B"-type scanning, are employed, some overscanning should be permitted to charge all of the storage elements in the normal viewing-beam field.

4. Stop writing. It is to be noted that the entire screen may not be uniformly bright at this point in the adjustment procedure.
 5. Readjust the voltage on G_{1V} toward cutoff until the display size is approximately 1-1/2 inches.
 6. Decrease G_{3V} voltage *slowly* until displayed spot diameter just reaches a maximum. Record the value of G_{3V} voltage at which this maximum spot diameter occurs.
 7. Decrease *slowly* the voltage on G_{1V} (thus making it more positive) until the display just reaches maximum diameter. This maximum diameter may coincide with the useful screen diameter of 4 inches. Record the value of G_{1V} voltage at which the diameter of the display is a maximum.
 8. Decrease voltage on G_{4V} until diameter of display starts to decrease. Record the voltage at which the decrease in diameter begins.
 9. Write full screen area to maximum brightness and then stop writing.
 10. Erase partially so that no part of the display is at full brightness and then stop erasing.
 11. Readjust voltage first on G_{3V} and then on G_{4V} to obtain the most uniform brightness (optimum uniformity) over the entire 4-inch-diameter display area. The readjustment should not involve changing the voltage on G_{3V} by more than ± 2 volts, nor the voltage on G_{4V} by more than ± 6 volts, from the recorded values in steps 6 and 8.
- NOTE: Due to charging of the storage surface by ion landing, and resultant non-uniformity, adjustment of the voltage on G_{3V} and on G_{4V} in this step should be made within 30 seconds after erasing is completed. If this time limit is exceeded, it will be necessary to restabilize the storage surface by repeating steps 9 and 10.
12. Repeat steps 9 and 10 and then readjust the voltage on G_{1V} over a range not exceeding ± 5 volts to establish optimum uniformity. Completion of this step should provide a full 4-inch-diameter display having satisfactory uniformity.

The above procedure may be carried out for other voltages applied to G_{5V} within its operating range (220 to 250 volts) to determine the voltage giving best uniformity.



REFERENCES

MIT Radar School Staff, "Principles of Radar", McGraw-Hill Book Co., Inc.

M. Knoll and B. Kazan, "Storage Tubes and Their Basic Principles", John Wiley and Sons, Inc.

M. Knoll, P. Rudnick, and H. O. Hook "Viewing Storage Tube with Halftone Display", RCA Review, Vol.14, No.4, December, 1953.

M. Knoll, H. O. Hook, and R. P. Stone, "Characteristics of a Transmission Control Viewing Storage Tube with Halftone Display", Proc. I.R.E., Vol.42, No.10, October, 1954.

DIMENSIONAL OUTLINE

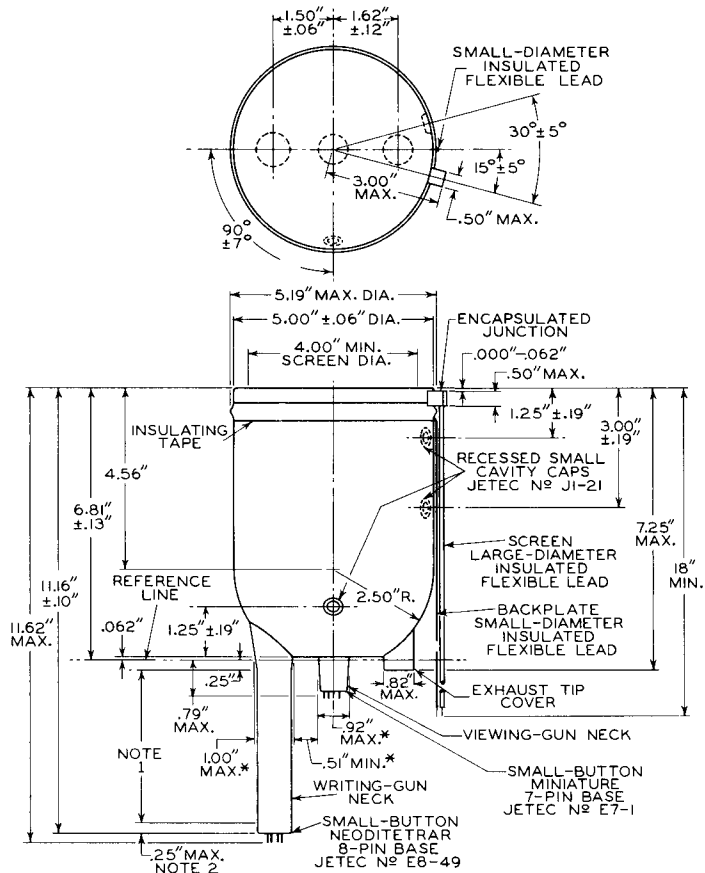

* AT REFERENCE LINE
 NOTE 1: WITHIN THIS DISTANCE, NECK DIAMETER IS .920" MAX.
 NOTE 2: WITHIN THIS DISTANCE, NECK DIAMETER IS .950" MAX.

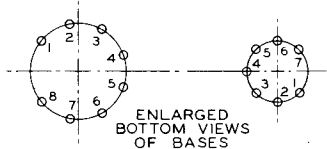

92CM-9580

Devices and arrangements shown or described herein may use patents of RCA or others. Information contained herein is furnished without responsibility by RCA for its use and without prejudice to RCA's patent rights.



SMALL-BUTTON MINIATURE 7-PIN BASE

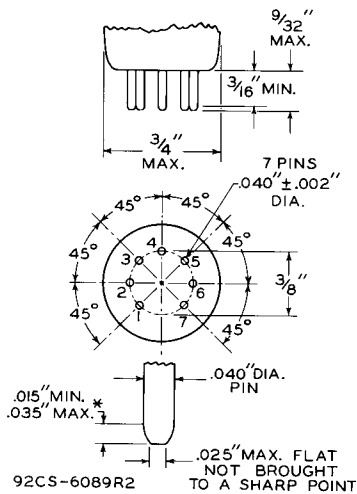

* This dimension around the periphery of any individual pin may vary within the limits shown.

BASE-PIN POSITIONS ARE HELD TO TOLERANCES SUCH THAT ENTIRE LENGTH OF PINS WILL, WITHOUT UNDUE FORCE, PASS INTO AND DISENGAGE FROM FLAT-PLATE GAUGE (PART OF GAUGE JETEC No. GE7-1) HAVING THICKNESS OF 1/4" AND EIGHT HOLES WITH DIAMETERS OF 0.0520" ± 0.0005" SO LOCATED ON A 0.3750" ± 0.0005" DIAMETER CIRCLE THAT THE DISTANCE ALONG THE CHORD BETWEEN ANY TWO ADJACENT HOLE CENTERS IS 0.1434" ± 0.0005".

THE DESIGN OF THE SOCKET SHOULD BE SUCH THAT CIRCUIT WIRING CAN NOT IMPRESS LATERAL STRAINS THROUGH THE SOCKET CONTACTS ON THE BASE PINS. THE POINT OF BEARING OF THE CONTACTS ON THE BASE PINS SHOULD NOT BE CLOSER THAN 1/8" FROM THE BOTTOM OF THE SEATED TUBE.

SMALL-BUTTON NEODITETRAR 8-PIN BASE

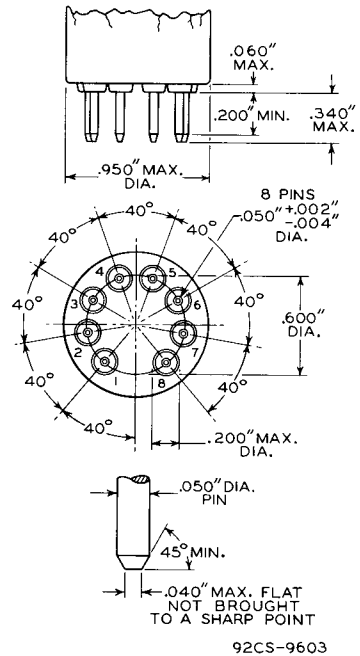

BASE-PIN POSITIONS ARE HELD TO TOLERANCES SUCH THAT ENTIRE LENGTH OF PINS WILL, WITHOUT UNDUE FORCE, PASS INTO AND DISENGAGE FROM FLAT-PLATE GAUGE HAVING THICKNESS OF 1/4" AND NINE HOLES WITH DIAMETER OF 0.0700" ± 0.0005" SO LOCATED ON A 0.6000" ± 0.0005" DIAMETER CIRCLE THAT THE DISTANCE ALONG THE CHORD BETWEEN ANY TWO ADJACENT HOLE CENTERS IS 0.2052" ± 0.0005".

SOCKET CONNECTIONS

Bottom View

VIEWING SECTION

Small-Button Miniature 7-Pin Base

- PIN 1: GRID No.2
- PIN 2: GRID No.1
- PIN 3: HEATER
- PIN 4: HEATER
- PIN 5: INTERNAL CONNECTION--DO NOT USE
- PIN 6: NO CONNECTION
- PIN 7: CATHODE
- FLEXIBLE LEAD (LARGE): SCREEN
- FLEXIBLE LEAD (SMALL): BACKPLATE
- RECESSED CAVITY CAP:
 - LOCATED 1-1/4" FROM TUBE FACE-- GRID No.5
 - LOCATED 3" FROM TUBE FACE-- GRID No.4
 - LOCATED NEAR VIEWING GUN--GRID No.3 AND GRIDS No.4 & No.2 OF WRITING GUN

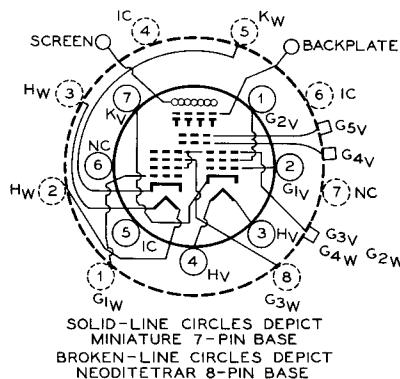

WRITING SECTION

Small-Button Neoditetrar 8-Pin Base

- PIN 1: GRID No.1
- PIN 2: HEATER
- PIN 3: HEATER
- PIN 4: INTERNAL CONNECTION-- DO NOT USE
- PIN 5: CATHODE
- PIN 6: INTERNAL CONNECTION-- DO NOT USE
- PIN 7: NO CONNECTION
- PIN 8: GRID No.3
- NOTE: GRIDS No.4 & No.2 ARE CONNECTED INTERNALLY TO GRID No.3 OF VIEWING GUN.